

**EVALUATION KIT  
AVAILABLE**



**MAX2023**

# High-Dynamic-Range, Direct Up-/Downconversion 1500MHz to 2300MHz Quadrature Mod/Demod

## General Description

The MAX2023 low-noise, high-linearity, direct upconversion/downconversion quadrature modulator/demodulator is designed for single and multicarrier 1500MHz to 2300MHz DCS 1800/PCS 1900 EDGE, cdma2000®, WCDMA, and PHS/PAS base-station applications. Direct conversion architectures are advantageous since they significantly reduce transmitter or receiver cost, part count, and power consumption as compared to traditional IF-based double-conversion systems.

In addition to offering excellent linearity and noise performance, the MAX2023 also yields a high level of component integration. This device includes two matched passive mixers for modulating or demodulating in-phase and quadrature signals, two LO mixer amplifier drivers, and an LO quadrature splitter. On-chip baluns are also integrated to allow for single-ended RF and LO connections. As an added feature, the baseband inputs have been matched to allow for direct interfacing to the transmit DAC, thereby eliminating the need for costly I/Q buffer amplifiers.

The MAX2023 operates from a single +5V supply. It is available in a compact 36-pin thin QFN package (6mm x 6mm) with an exposed paddle. Electrical performance is guaranteed over the extended -40°C to +85°C temperature range.

## Applications

Single-Carrier DCS 1800/PCS 1900 EDGE Base Stations  
Single and Multicarrier WCDMA/UMTS Base Stations  
Single and Multicarrier cdmaOne™ and cdma2000 Base Stations  
Predistortion Transmitters and Receivers  
PHS/PAS Base Stations  
Fixed Broadband Wireless Access  
Military Systems  
Microwave Links  
Digital and Spread-Spectrum Communication Systems  
Video-on-Demand (VOD) and DOCSIS Compliant Edge QAM Modulation  
Cable Modem Termination Systems (CMTS)

cdma2000 is a registered trademark of Telecommunications Industry Association.  
cdmaOne is a trademark of CDMA Development Group.

## Features

- ◆ 1500MHz to 2300MHz RF Frequency Range
- ◆ Scalable Power: External Current-Setting Resistors Provide Option for Operating Device in Reduced-Power/Reduced-Performance Mode
- ◆ 36-Pin, 6mm x 6mm TQFN Provides High Isolation in a Small Package

### Modulator Operation:

- ◆ Meets GSM Spurious Emission of -75dBc at 600kHz Offset at P<sub>OUT</sub> = +6dBm
- ◆ +23.5dBm Typical OIP3
- ◆ +61dBm Typical OIP2
- ◆ +16dBm Typical OP1dB
- ◆ -54dBm Typical LO Leakage
- ◆ 48dBc Typical Sideband Suppression
- ◆ -165dBc/Hz Output Noise Density
- ◆ Broadband Baseband Input of 450MHz Allows a Direct Launch DAC Interface, Eliminating the Need for Costly I/Q Buffer Amplifiers
- ◆ DC-Coupled Input Allows Ability for Offset Voltage Control

### Demodulator Operation:

- ◆ +38dBm Typical IIP3
- ◆ +59dBm Typical IIP2
- ◆ +30dBm Typical IP1dB
- ◆ 9.5dB Typical Conversion Loss
- ◆ 9.6dB Typical NF
- ◆ 0.025dB Typical I/Q Gain Imbalance
- ◆ 0.56° I/Q Typical Phase Imbalance

## Ordering Information

PART	TEMP RANGE	PIN-PACKAGE	PKG CODE
MAX2023ETX	-40°C to +85°C	36 Thin QFN-EP* (6mm x 6mm)	T3666-2
MAX2023ETX-T	-40°C to +85°C	36 Thin QFN-EP* (6mm x 6mm)	T3666-2
MAX2023ETX+	-40°C to +85°C	36 Thin QFN-EP* (6mm x 6mm)	T3666-2
MAX2023ETX+T	-40°C to +85°C	36 Thin QFN-EP* (6mm x 6mm)	T3666-2

\*EP = Exposed paddle.  
+ Denotes lead-free package.  
T = Tape-and-reel package.



**For pricing, delivery, and ordering information, please contact Maxim/Dallas Direct! at 1-888-629-4642, or visit Maxim's website at www.maxim-ic.com.**

# High-Dynamic-Range, Direct Up-/Downconversion 1500MHz to 2300MHz Quadrature Mod/Demod

## ABSOLUTE MAXIMUM RATINGS

VCC_ to GND .....	-0.3V to +5.5V	RBIASLO3 Maximum Current .....	10mA
BBI+, BBI-, BBQ+, BBQ- to GND.....	-4V to (VCC + 0.3V)	$\theta_{JA}$ (without air flow) .....	34°C/W
LO, RF to GND Maximum Current .....	30mA	$\theta_{JA}$ (2.5m/s air flow) .....	28°C/W
RF Input Power .....	+30dBm	$\theta_{JC}$ (junction to exposed paddle) .....	8.5°C/W
Baseband Differential I/Q Input Power .....	+20dBm	Junction Temperature .....	+150°C
LO Input Power.....	+10dBm	Storage Temperature Range .....	-65°C to +150°C
RBIASLO1 Maximum Current .....	10mA	Lead Temperature (soldering 10s, leaded).....	+245°C
RBIASLO2 Maximum Current .....	10mA	Lead Temperature (soldering 10s, lead free).....	+260°C

Stresses beyond those listed under "Absolute Maximum Ratings" may cause permanent damage to the device. These are stress ratings only, and functional operation of the device at these or any other conditions beyond those indicated in the operational sections of the specifications is not implied. Exposure to absolute maximum rating conditions for extended periods may affect device reliability.

## DC ELECTRICAL CHARACTERISTICS

(MAX2023 Typical Application Circuit, VCC = +4.75V to +5.25V, GND = 0V, I/Q inputs terminated into 100 $\Omega$  differential, LO input terminated into 50 $\Omega$ , RF output terminated into 50 $\Omega$ , 0V common-mode input, R1 = 432 $\Omega$ , R2 = 562 $\Omega$ , R3 = 300 $\Omega$ , TC = -40°C to +85°C, unless otherwise noted. Typical values are at VCC = +5V, TC = +25°C, unless otherwise noted.) (Note 1)

PARAMETER	CONDITIONS	MIN	TYP	MAX	UNITS
Supply Voltage		4.75	5.00	5.25	V
Supply Current	(Note 2)	255	295	345	mA

## AC ELECTRICAL CHARACTERISTICS (Modulator)

(MAX2023 Typical Application Circuit, when operated as a modulator, VCC = +4.75V to +5.25V, GND = 0V, I/Q differential inputs driven from a 100 $\Omega$  DC-coupled source, 0V common-mode input, 50 $\Omega$  LO and RF system impedance, R1 = 432 $\Omega$ , R2 = 562 $\Omega$ , R3 = 300 $\Omega$ , TC = -40°C to +85°C. Typical values are at VCC = +5V, VBBI = VBBQ = 2.66Vp-p differential, fIQ = 1MHz, PLO = 0dBm, TC = +25°C, unless otherwise noted.) (Note 1)

PARAMETER	CONDITIONS	MIN	TYP	MAX	UNITS
<b>BASEBAND INPUT</b>					
Baseband Input Differential Impedance	fIQ = 1MHz		55		$\Omega$
BB Common-Mode Input Voltage Range	VBBI = VBBQ = 1Vp-p differential		$\pm 3.5$		V
Baseband 0.5dB Bandwidth			450		MHz
<b>LO INPUT</b>					
LO Input Frequency Range		1500		2300	MHz
LO Input Drive		-3		+3	dBm
LO Input Return Loss			15		dB
<b>RF OUTPUT</b>					
Output IP3	P <sub>OUT</sub> = 0dBm, f <sub>BB1</sub> = 1.8MHz, f <sub>BB2</sub> = 1.9MHz	f <sub>LO</sub> = 1750MHz		+24.2	dBm
		f <sub>LO</sub> = 1850MHz		+23.5	
		f <sub>LO</sub> = 1950MHz		+22	
Output IP2	P <sub>OUT</sub> = 0dBm, f <sub>BB1</sub> = 1.8MHz, f <sub>BB2</sub> = 1.9MHz, f <sub>LO</sub> = 1850MHz		+61		dBm
Output P <sub>1dB</sub>	CW tone	f <sub>LO</sub> = 1750MHz		+15.9	dBm
		f <sub>LO</sub> = 1850MHz		+14.3	
		f <sub>LO</sub> = 1950MHz		+12.5	
Output Power	(Note 3)		+5.6		dBm

# High-Dynamic-Range, Direct Up-/Downconversion 1500MHz to 2300MHz Quadrature Mod/Demod

## AC ELECTRICAL CHARACTERISTICS (Modulator) (continued)

(MAX2023 *Typical Application Circuit*, when operated as a modulator,  $V_{CC} = +4.75V$  to  $+5.25V$ ,  $GND = 0V$ , I/Q differential inputs driven from a  $100\Omega$  DC-coupled source,  $0V$  common-mode input,  $50\Omega$  LO and RF system impedance,  $R1 = 432\Omega$ ,  $R2 = 562\Omega$ ,  $R3 = 300\Omega$ ,  $T_C = -40^\circ C$  to  $+85^\circ C$ . Typical values are at  $V_{CC} = +5V$ ,  $V_{BBI} = V_{BBQ} = 2.66V_{P-P}$  differential,  $f_{IQ} = 1MHz$ ,  $P_{LO} = 0dBm$ ,  $T_C = +25^\circ C$ , unless otherwise noted.) (Note 1)

Output Power Variation Over Temperature	$P_{OUT} = +5.6dBm$ , $f_{I/Q} = 100kHz$ , $T_C = -40^\circ C$ to $+85^\circ C$		0.25	dB
Output-Power Flatness	$f_{LO} = 1850MHz$ , $P_{RF}$ flatness for $f_{LO}$ swept over $\pm 50MHz$ range		0.2	dB
RF Return Loss	$f_{LO} = 1850MHz$		17	dB
Single Sideband Rejection	No external calibration	$f_{LO} = 1750MHz$	51	dBc
		$f_{LO} = 1850MHz$	48	
		$f_{LO} = 1950MHz$	48	
Spurious Emissions	$P_{OUT} = +6dBm$ , $f_{LO} = 1850MHz$ , EDGE input	200kHz offset	-37.2	dBc/ 30kHz
		400kHz offset	-71.4	
		600kHz offset	-84.7	
		1.2MHz offset	-85	
Error Vector Magnitude	EDGE input	RMS	0.67	%
		Peak	1.5	
Output Noise Density	(Note 4)		-174	dBm/Hz
Output Noise Floor	$P_{OUT} = 0dBm$ (Note 5)		-165	dBm/Hz
LO Leakage	Un-nulled, baseband inputs terminated in $50\Omega$	$f_{LO} = 1750MHz$	-59	dBm
		$f_{LO} = 1850MHz$	-54	
		$f_{LO} = 1950MHz$	-48	

## AC ELECTRICAL CHARACTERISTICS (Demodulator)

(MAX2023 *Typical Application Circuit* when operated as a demodulator,  $V_{CC} = +4.75V$  to  $+5.25V$ ,  $GND = 0V$ ,  $50\Omega$  LO and RF system impedance,  $R1 = 432\Omega$ ,  $R2 = 562\Omega$ ,  $R3 = 300\Omega$ ,  $T_C = -40^\circ C$  to  $+85^\circ C$ . Typical values are at  $V_{CC} = +5V$ ,  $P_{RF} = 0dBm$ ,  $f_{BB} = 1MHz$ ,  $P_{LO} = 0dBm$ ,  $f_{LO} = 1850MHz$ ,  $T_C = +25^\circ C$ , unless otherwise noted.) (Note 1)

PARAMETER	CONDITIONS	MIN	TYP	MAX	UNITS
<b>RF INPUT</b>					
RF Input Frequency		1500		2300	MHz
Conversion Loss	$f_{BB} = 25MHz$		9.5		dB
Noise Figure			9.6		dB
Noise Figure Underblocking Conditions	$f_{BLOCKER} = 1950MHz$ , $P_{BLOCKER} = +11dBm$ , $f_{RF} = 1850MHz$ (Note 6)		20.3		dB
Input Third-Order Intercept Point	$f_{RF1} = 1875MHz$ , $f_{RF2} = 1876MHz$ , $f_{LO} = 1850MHz$ , $P_{RF} = P_{LO} = 0dBm$ , $f_{IM3} = 24MHz$		38		dBm
Input Second-Order Intercept Point	$f_{RF1} = 1875MHz$ , $f_{RF2} = 1876MHz$ , $f_{LO} = 1850MHz$ , $P_{RF} = P_{LO} = 0dBm$ , $f_{IM2} = 51MHz$		59		dBm
Input 1dB Compression Point	$f_{BB} = 25MHz$		29.7		dBm
I/Q Gain Mismatch	$f_{BB} = 1MHz$		0.025		dB
I/Q Phase Mismatch	$f_{BB} = 1MHz$		0.56		Degrees

# High-Dynamic-Range, Direct Up-/Downconversion 1500MHz to 2300MHz Quadrature Mod/Demod

**Note 1:**  $T_C$  is the temperature on the exposed paddle.

**Note 2:** Guaranteed by production test.

**Note 3:**  $V_{I/Q} = 2.66V_{P-P}$  differential CW input.

**Note 4:** No baseband drive input. Measured with the baseband inputs terminated in  $50\Omega$ . At low output power levels, the output noise density is equal to the thermal noise floor. See Output Noise Density vs. Output Power plots in *Typical Operating Characteristics*.

**Note 5:** The output noise vs.  $P_{OUT}$  curve has the slope of LO noise ( $L_n$  dBc/Hz) due to reciprocal mixing. Measured at 10MHz offset from carrier.

**Note 6:** The LO noise ( $L = 10^{(L_n/10)}$ ), determined from the modulator measurements can be used to deduce the noise figure underblocking at operating temperature ( $T_P$  in Kelvin),  $f_{BLOCK} = 1 + (L_{CN} - 1) T_P / T_O + LP_{BLOCK} / (1000kT_O)$ , where  $T_O = 290K$ ,  $P_{BLOCK}$  in mW,  $k$  is Boltzmann's constant =  $1.381 \times 10^{-23}$  J/K, and  $L_{CN} = 10^{(L_c/10)}$ ,  $L_c$  is the conversion loss. Noise figure underblocking in dB is  $NF_{BLOCK} = 10 \times \log(f_{BLOCK})$ . Refer to *Application Note 3632*.

## Typical Operating Characteristics

(MAX2023 *Typical Application Circuit*,  $V_{CC} = +4.75V$  to  $+5.25V$ ,  $GND = 0V$ , I/Q differential inputs driven from a  $100\Omega$  DC-coupled source (modulator),  $V_{BBI} = V_{BBQ} = 2.66V_{P-P}$  differential (modulator),  $P_{RF} = +6dBm$  (demodulator), I/Q differential output drives  $50\Omega$  differential load (demodulator),  $0V$  common-mode input/output,  $P_{LO} = 0dBm$ ,  $1500MHz \leq f_{LO} \leq 2300MHz$ ,  $50\Omega$  LO and RF system impedance,  $R1 = 432\Omega$ ,  $R2 = 562\Omega$ ,  $R3 = 300\Omega$ ,  $T_C = -40^\circ C$  to  $+85^\circ C$ . Typical values are at  $V_{CC} = +5V$ ,  $f_{LO} = 1850MHz$ ,  $T_C = +25^\circ C$ , unless otherwise noted.)

SUPPLY CURRENT vs. TEMPERATURE ( $T_C$ )

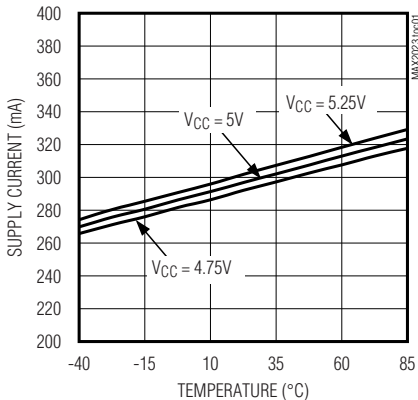

MODULATOR SINGLE-SIDEBAND SUPPRESSION vs. LO FREQUENCY

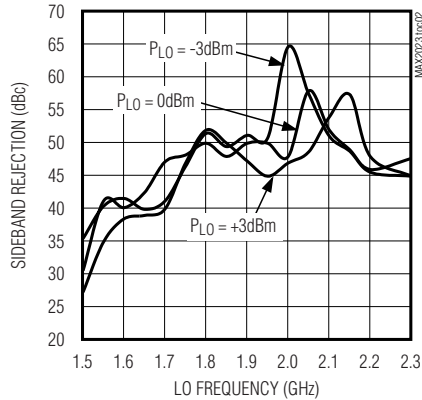

MODULATOR SINGLE-SIDEBAND SUPPRESSION vs. LO FREQUENCY

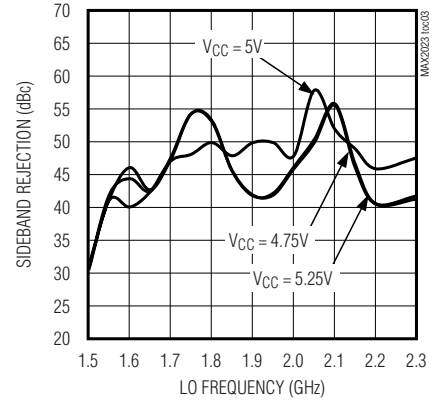

MODULATOR SINGLE-SIDEBAND SUPPRESSION vs. LO FREQUENCY

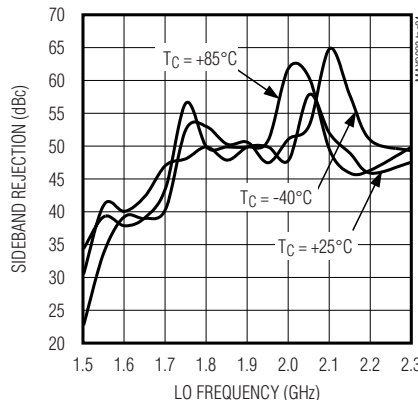

MODULATOR OUTPUT IP3 vs. LO FREQUENCY

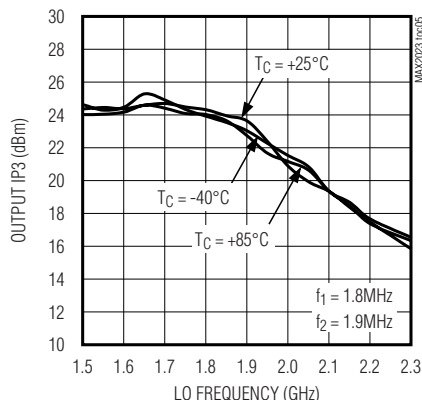

MODULATOR OUTPUT IP3 vs. LO FREQUENCY

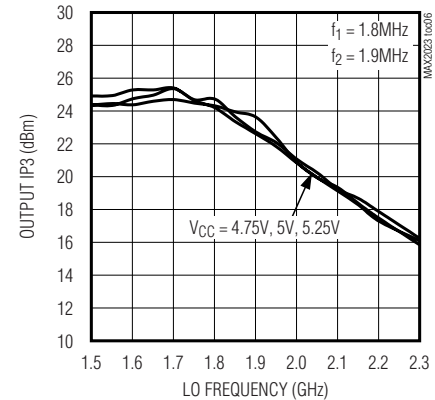

# High-Dynamic-Range, Direct Up-/Downconversion 1500MHz to 2300MHz Quadrature Mod/Demod

## Typical Operating Characteristics (continued)

(MAX2023 Typical Application Circuit,  $V_{CC} = +4.75V$  to  $+5.25V$ ,  $GND = 0V$ , I/Q differential inputs driven from a  $100\Omega$  DC-coupled source (modulator),  $V_{BB1} = V_{BBQ} = 2.6V_{P-P}$  differential (modulator),  $P_{RF} = +6dBm$  (demodulator), I/Q differential output drives  $50\Omega$  differential load (demodulator),  $0V$  common-mode input/output,  $P_{LO} = 0dBm$ ,  $1500MHz \leq f_{LO} \leq 2300MHz$ ,  $50\Omega$  LO and RF system impedance,  $R1 = 432\Omega$ ,

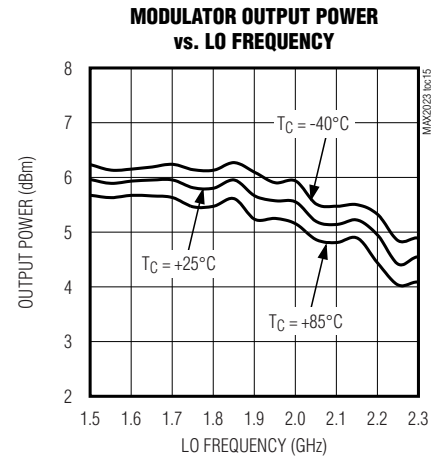
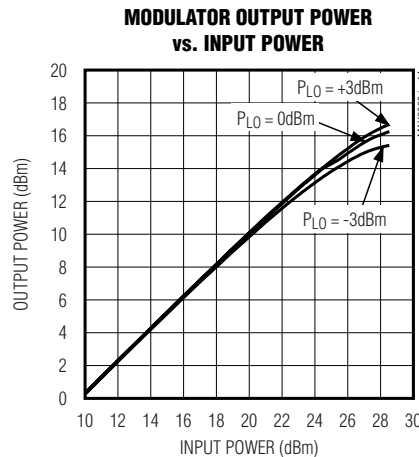
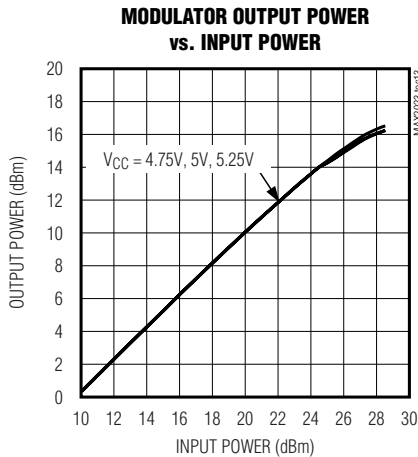
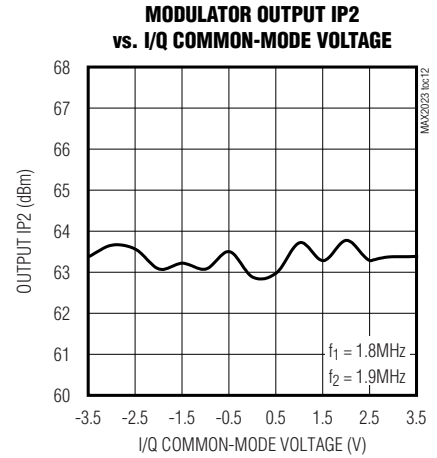
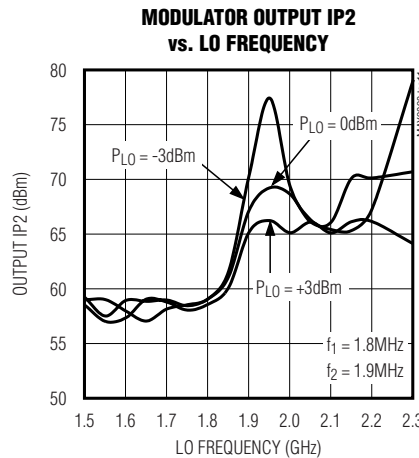
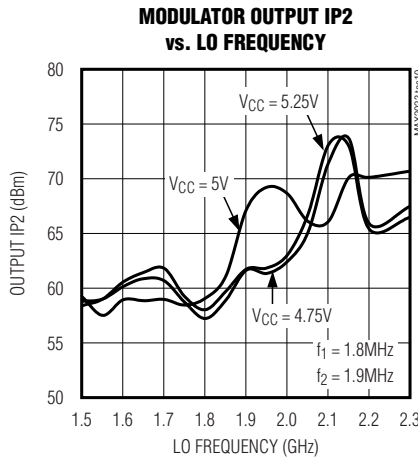
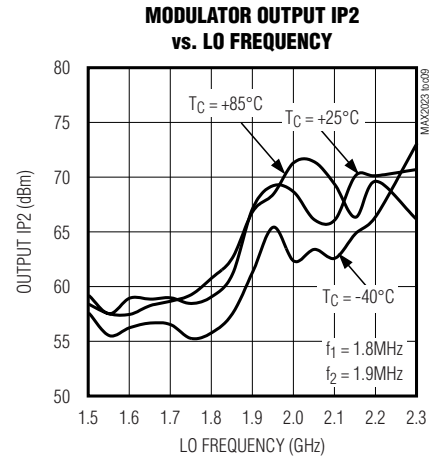
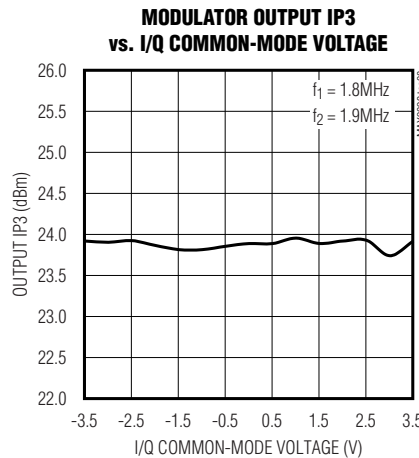
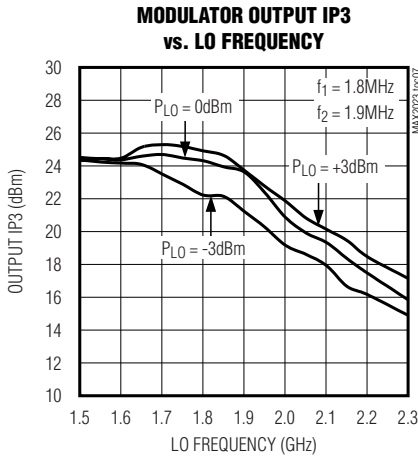

# High-Dynamic-Range, Direct Up-/Downconversion 1500MHz to 2300MHz Quadrature Mod/Demod

## Typical Operating Characteristics (continued)

(MAX2023 Typical Application Circuit,  $V_{CC} = +4.75V$  to  $+5.25V$ ,  $GND = 0V$ , I/Q differential inputs driven from a  $100\Omega$  DC-coupled source (modulator),  $V_{BBI} = V_{BBQ} = 2.6V_{P-P}$  differential (modulator),  $P_{RF} = +6dBm$  (demodulator), I/Q differential output drives  $50\Omega$  differential load (demodulator),  $0V$  common-mode input/output,  $P_{LO} = 0dBm$ ,  $1500MHz \leq f_{LO} \leq 2300MHz$ ,  $50\Omega$  LO and RF system impedance,  $R1 = 432\Omega$ ,

**MODULATOR OUTPUT POWER vs. BASEBAND FREQUENCY**

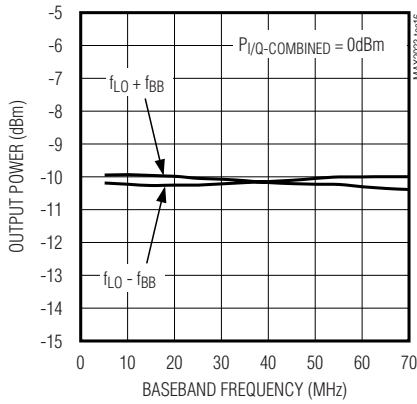

**MODULATOR LO LEAKAGE vs. LO FREQUENCY**

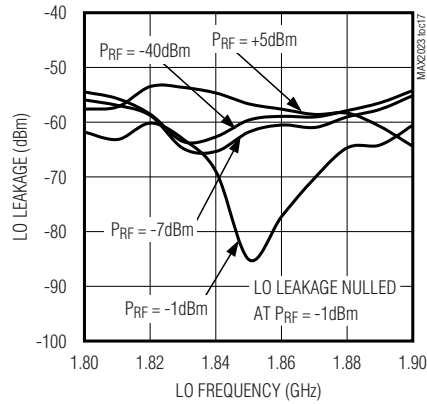

**MODULATOR LO LEAKAGE vs. LO FREQUENCY**

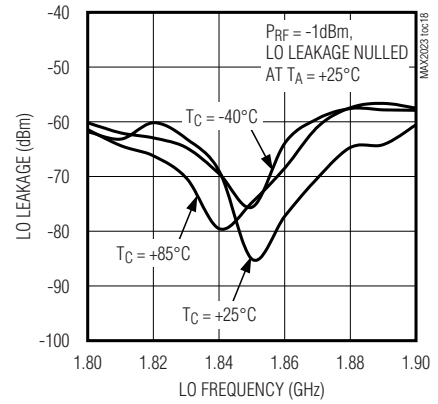

**MODULATOR LO LEAKAGE vs. LO FREQUENCY**

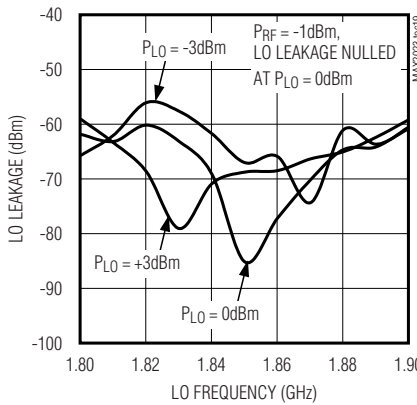

**MODULATOR OUTPUT NOISE DENSITY vs. OUTPUT POWER**

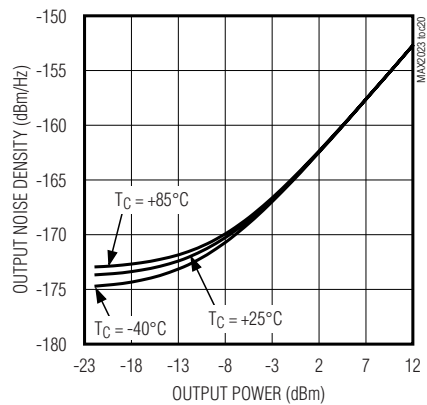

**MODULATOR OUTPUT NOISE DENSITY vs. OUTPUT POWER**

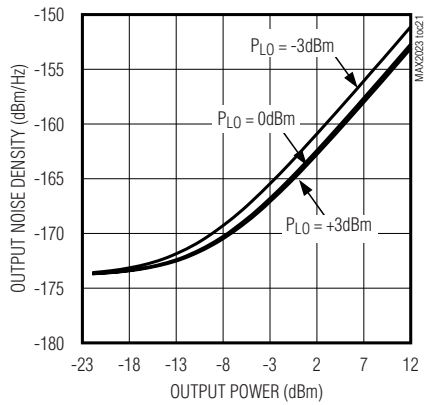

**DEMODULATOR CONVERSION LOSS vs. LO FREQUENCY**

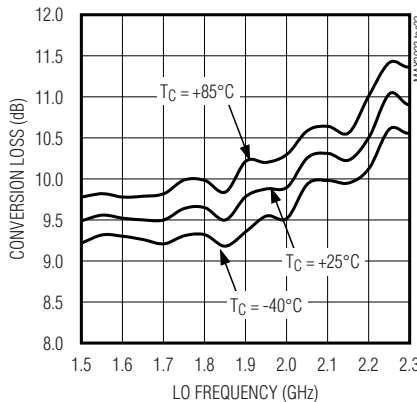

**DEMODULATOR INPUT IP3 vs. LO FREQUENCY**

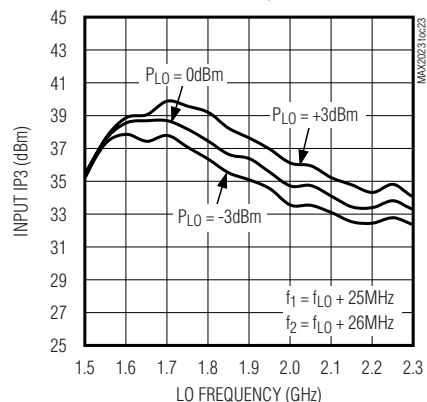

**DEMODULATOR INPUT IP3 vs. LO FREQUENCY**

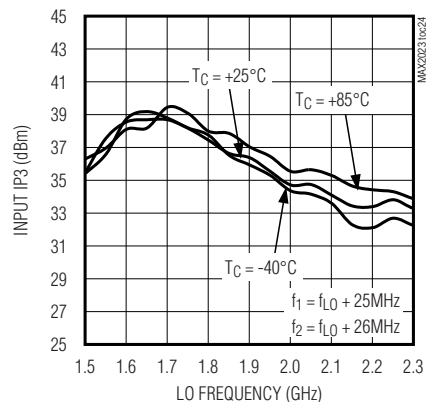

# High-Dynamic-Range, Direct Up-/Downconversion 1500MHz to 2300MHz Quadrature Mod/Demod

## Typical Operating Characteristics (continued)

(MAX2023 Typical Application Circuit,  $V_{CC} = +4.75V$  to  $+5.25V$ ,  $GND = 0V$ , I/Q differential inputs driven from a  $100\Omega$  DC-coupled source (modulator),  $V_{BBI} = V_{BBQ} = 2.6V_{P-P}$  differential (modulator),  $P_{RF} = +6dBm$  (demodulator), I/Q differential output drives  $50\Omega$  differential load (demodulator),  $0V$  common-mode input/output,  $P_{LO} = 0dBm$ ,  $1500MHz \leq f_{LO} \leq 2300MHz$ ,  $50\Omega$  LO and RF system impedance,  $R1 = 432\Omega$ ,  $R2 = 562\Omega$ ,  $R3 = 300\Omega$ ,  $T_C = -40^\circ C$  to  $+85^\circ C$ . Typical values are at  $V_{CC} = +5V$ ,  $f_{LO} = 1850MHz$ ,  $T_C = +25^\circ C$ , unless otherwise noted.)

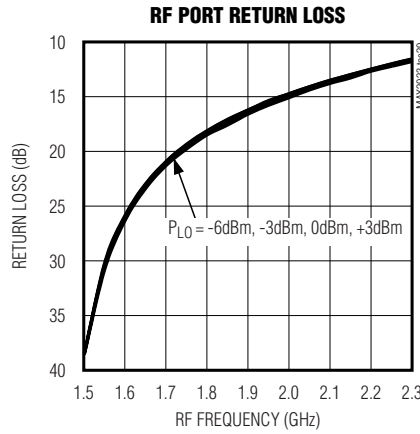
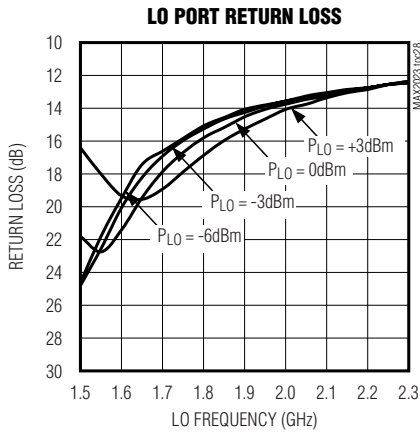
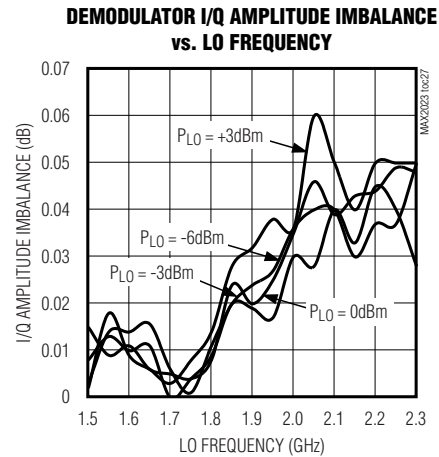
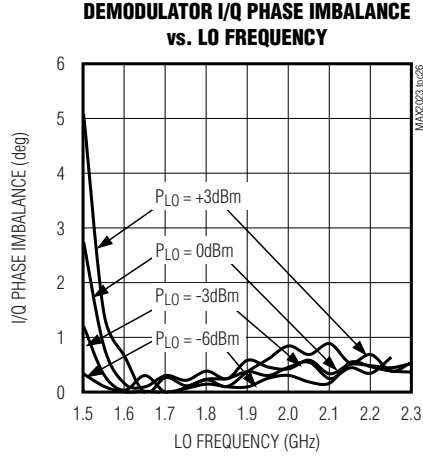
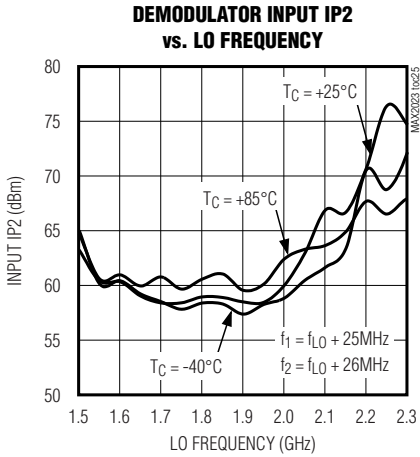

# High-Dynamic-Range, Direct Up-/Downconversion 1500MHz to 2300MHz Quadrature Mod/Demod

## Pin Description

PIN	NAME	FUNCTION
1, 5, 9–12, 14, 16–19, 22, 24, 27–30, 32, 34, 35, 36	GND	Ground
2	RBIASLO3	3rd LO Amplifier Bias. Connect a 300Ω resistor to ground.
3	VCCLOA	LO Input Buffer Amplifier Supply Voltage. Bypass to GND with 22pF and 0.1μF capacitors as close to the pin as possible.
4	LO	Local Oscillator Input. 50Ω input impedance. Requires a DC-blocking capacitor.
6	RBIASLO1	1st LO Input Buffer Amplifier Bias. Connect a 432Ω resistor to ground.
7	N.C.	No Connection. Leave unconnected.
8	RBIASLO2	2nd LO Amplifier Bias. Connect a 562Ω resistor to ground.
13	VCCLOI1	I-Channel 1st LO Amplifier Supply Voltage. Bypass to GND with 22pF and 0.1μF capacitors as close to the pin as possible.
15	VCCLOI2	I-Channel 2nd LO Amplifier Supply Voltage. Bypass to GND with 22pF and 0.1μF capacitors as close to the pin as possible.
20	BBI+	Baseband In-Phase Noninverting Port
21	BBI-	Baseband In-Phase Inverting Port
23	RF	RF Port. This port is matched to 50Ω. Requires a DC-blocking capacitor.
25	BBQ-	Baseband Quadrature Inverting Port
26	BBQ+	Baseband Quadrature Noninverting Port
31	VCCLOQ2	Q-Channel 2nd LO Amplifier Supply Voltage. Bypass to GND with 22pF and 0.1μF capacitors as close to the pin as possible.
33	VCCLOQ1	Q-Channel 1st LO Amplifier Supply Voltage. Bypass to GND with 22pF and 0.1μF capacitors as close to the pin as possible.
EP	GND	Exposed Ground Paddle. The exposed paddle <b>MUST</b> be soldered to the ground plane using multiple vias.

## Detailed Description

The MAX2023 is designed for upconverting differential in-phase (I) and quadrature (Q) inputs from baseband to a 1500MHz to 2300MHz RF frequency range. The device can also be used as a demodulator, downconverting an RF input signal directly to baseband. Applications include single and multicarrier 1500MHz to 2300MHz DCS/PCS EDGE, UMTS/WCDMA, cdma2000, and PHS/PAS base stations. Direct conversion architectures are advantageous since they significantly reduce transmitter or receiver cost, part count, and power consumption as compared to traditional IF-based double-conversion systems.

The MAX2023 integrates internal baluns, an LO buffer, a phase splitter, two LO driver amplifiers, two matched double-balanced passive mixers, and a wideband quadrature combiner. The MAX2023's high-linearity mixers, in conjunction with the part's precise in-phase and quadrature channel matching, enable the device to possess excellent dynamic range, ACLR, 1dB compression point, and LO and sideband suppression characteristics. These features make the MAX2023 ideal for single-carrier GSM and multicarrier WCDMA operation.

## LO Input Balun, LO Buffer, and Phase Splitter

The MAX2023 requires a single-ended LO input, with a nominal power of 0dBm. An internal low-loss balun at the LO input converts the single-ended LO signal to a differential signal at the LO buffer input. In addition, the internal balun matches the buffer's input impedance to 50Ω over the entire band of operation.

The output of the LO buffer goes through a phase splitter, which generates a second LO signal that is shifted by 90° with respect to the original. The 0° and 90° LO signals drive the I and Q mixers, respectively.

## LO Driver

Following the phase splitter, the 0° and 90° LO signals are each amplified by a two-stage amplifier to drive the I and Q mixers. The amplifier boosts the level of the LO signals to compensate for any changes in LO drive levels. The two-stage LO amplifier allows a wide input power range for the LO drive. The MAX2023 can tolerate LO level swings from -3dBm to +3dBm.



# High-Dynamic-Range, Direct Up-/Downconversion 1500MHz to 2300MHz Quadrature Mod/Demod

## I/Q Modulator

The MAX2023 modulator is composed of a pair of matched double-balanced passive mixers and a balun. The I and Q differential baseband inputs accept signals from DC to 450MHz with differential amplitudes up to 4V<sub>p-p</sub>. The wide input bandwidths allow operation of the MAX2023 as either a direct RF modulator or as an image-reject mixer. The wide common-mode compliance range allows for direct interface with the baseband DACs. No active buffer circuitry is required between the baseband DACs and the MAX2023 for wideband applications.

The I and Q signals directly modulate the 0° and 90° LO signals and are upconverted to the RF frequency. The outputs of the I and Q mixers are combined through a balun to produce a singled-ended RF output.

## Applications Information

### LO Input Drive

The LO input of the MAX2023 is internally matched to 50Ω, and requires a single-ended drive at a 1500MHz to 2300MHz frequency range. An integrated balun converts the singled-ended input signal to a differential signal at the LO buffer differential input. An external DC-blocking capacitor is the only external part required at this interface. The LO input power should be within the -3dBm to +3dBm range. An LO input power of 0dBm is recommended for best overall performance.

### Baseband I/Q Input Drive

Drive the MAX2023 I and Q baseband inputs differentially for best performance. The baseband inputs have a 50Ω differential input impedance. The optimum source impedance for the I and Q inputs is 100Ω differential. This source impedance achieves the optimal signal transfer to the I and Q inputs, and the optimum output RF impedance match. The MAX2023 can accept input power levels of up to +20dBm on the I and Q inputs. Operation with complex waveforms, such as CDMA carriers or GSM signals, utilize input power levels that are far lower. This lower power operation is made necessary by the high peak-to-average ratios of these complex waveforms. The peak signals must be kept below the compression level of the MAX2023. The input common-mode voltage should be confined to the -3.5V to +3.5V DC range.

### WCDMA Transmitter Applications

The MAX2023 is designed to interface directly with Maxim high-speed DACs. This generates an ideal total transmitter lineup, with minimal ancillary circuit elements required for widespread applications. Such DACs include the MAX5875 series of dual DACs, and the

MAX5895 dual interpolating DAC. These DACs have ground-referenced differential current outputs. Typical termination of each DAC output into a 50Ω load resistor to ground, and a 10mA nominal DC output current results in a 0.5V common-mode DC level into the modulator I/Q inputs. The nominal signal level provided by the DACs will be in the -12dBm range for a single CDMA or WCDMA carrier, reducing to -18dBm per carrier for a four-carrier application.

The I/Q input bandwidth is greater than 450MHz at -0.5dB response. The direct connection of the DAC to the MAX2023 ensures the maximum signal fidelity, with no performance-limiting baseband amplifiers required. The DAC output can be passed through a lowpass filter to remove the image frequencies from the DAC's output response. The MAX5895 dual interpolating DAC can be operated at interpolation rates up to x8. This has the benefit of moving the DAC image frequencies to a very high, remote frequency, easing the design of the baseband filters. The DAC's output noise floor and interpolation filter stopband attenuation are sufficiently good to ensure that the 3GPP noise floor requirement is met for large frequency offsets, 60MHz for example, with no filtering required on the RF output of the modulator.

Figure 1 illustrates the ease and efficiency of interfacing the MAX2023 with a Maxim DAC, in this case the MAX5895 dual 16-bit interpolating-modulating DAC.

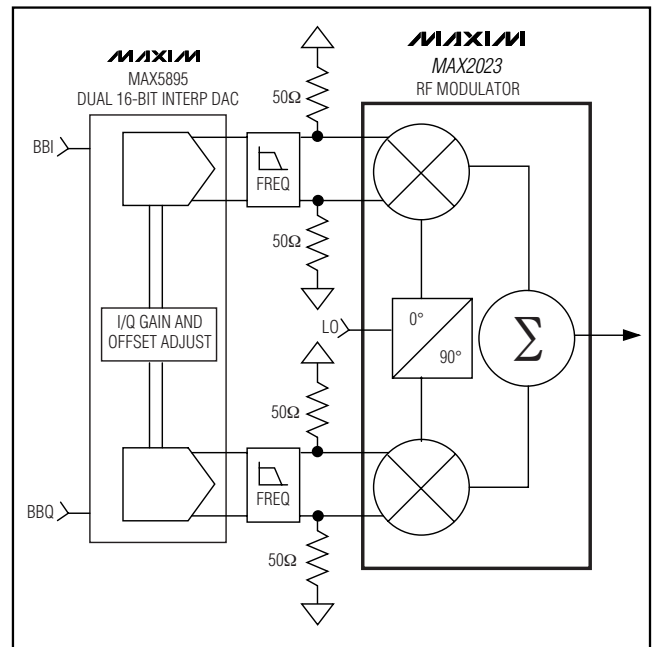

Figure 1. MAX5895 DAC Interfaced with MAX2023 for cdma2000 and WCDMA Base Stations

# High-Dynamic-Range, Direct Up-/Downconversion 1500MHz to 2300MHz Quadrature Mod/Demod

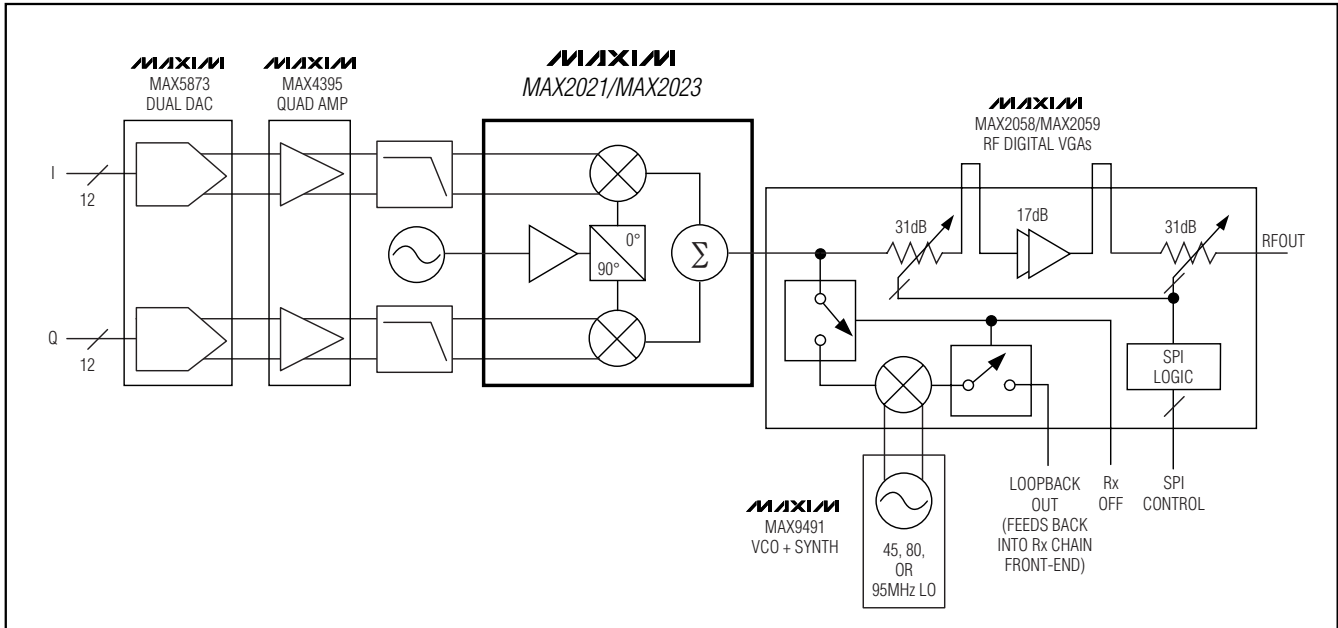

Figure 2. Complete Transmitter Lineup for GSM/EDGE DCS/PCS-Band Base Stations

The MAX5895 DAC has programmable gain and differential offset controls built in. These can be used to optimize the LO leakage and sideband suppression of the MAX2023 quadrature modulator.

## GSM Transmitter Applications

The MAX2023 is an ideal modulator for a zero-IF (ZIF), single-carrier GSM transmitter. The device's wide dynamic range enables a very efficient overall transmitter architecture. Figure 2 illustrates the exceptionally simple complete lineup for a high-performance GSM/EDGE transmitter.

The single-carrier GSM transmit lineup generates baseband I and Q signals from a simple 12-bit dual DAC such as the MAX5873. The DAC clock rate can be a multiple of the GSM system clock rate of 13MHz. The ground-referenced outputs of the dual DAC are filtered by simple discrete element lowpass filters to attenuate both the DAC images and the noise floor. The I and Q baseband signals are then level shifted and amplified by a MAX4395 quad operational amplifier, configured as a differential input/output amplifier. This amplifier can deliver a baseband power level of greater than +15dBm to the MAX2023, enabling very high RF output power levels. The MAX2023 will deliver up to +5dBm for GSM vectors with full conformance to the required system specifications with large margins. The exceptionally low phase noise of the MAX2023 allows the cir-

cuit to meet the GSM system level noise requirements with no additional RF filters required, greatly simplifying the overall lineup.

The output of the MAX2023 drives a MAX2059 RF VGA, which can deliver up to +15dBm of GSM carrier power and includes a very flexible digitally controlled attenuator with over 56dB of adjustment range. This accommodates the full static and dynamic power-control requirements, with extra range for lineup gain compensation.

## RF Output

The MAX2023 utilizes an internal passive mixer architecture that enables the device to possess an exceptionally low-output noise floor. With such architectures, the total output noise is typically a power summation of the theoretical thermal noise (kTB) and the noise contribution from the on-chip LO buffer circuitry. As demonstrated in the *Typical Operating Characteristics*, the MAX2023's output noise approaches the thermal limit of -174dBm/Hz for lower output power levels. As the output power increases, the noise level tracks the noise contribution from the LO buffer circuitry, which is approximately -165dBc/Hz.

The I/Q input power levels and the insertion loss of the device determine the RF output power level. The input power is a function of the delivered input I and Q voltages to the internal 50Ω termination. For simple sinu-

# High-Dynamic-Range, Direct Up-/Downconversion 1500MHz to 2300MHz Quadrature Mod/Demod

soidal baseband signals, a level of 89mV<sub>p-p</sub> differential on the I and the Q inputs results in a -17dBm input power level delivered to the I and Q internal 50Ω terminations. This results in an RF output power of -26.6dBm.

### External Diplexer

LO leakage at the RF port can be nulled to a level less than -80dBm by introducing DC offsets at the I and Q ports. However, this null at the RF port can be compromised by an improperly terminated I/Q IF interface. Care must be taken to match the I/Q ports to the driving DAC circuitry. Without matching, the LO's second-order ( $2f_{LO}$ ) term may leak back into the modulator's I/Q input port where it can mix with the internal LO signal to produce additional LO leakage at the RF output. This leakage effectively counteracts against the LO nulling. In addition, the LO signal reflected at the I/Q IF port produces a residual DC term that can disturb the nulling condition.

As demonstrated in Figure 3, providing an RC termination on each of the I+, I-, Q+, Q- ports reduces the amount of LO leakage present at the RF port under varying temperature, LO frequency, and baseband termination conditions. See the *Typical Operating Characteristics* for details. Note that the resistor value is chosen to be 50Ω with a corner frequency  $1 / (2\pi RC)$  selected to adequately filter the  $f_{LO}$  and  $2f_{LO}$  leakage, yet not affecting the flatness of the baseband response at the highest baseband frequency. The common-mode  $f_{LO}$  and  $2f_{LO}$  signals at I+/I- and Q+/Q- effectively see the RC networks and thus

become terminated in 25Ω (R/2). The RC network provides a path for absorbing the  $2f_{LO}$  and  $f_{LO}$  leakage, while the inductor provides high impedance at  $f_{LO}$  and  $2f_{LO}$  to help the diplexing process.

### RF Demodulator

The MAX2023 can also be used as an RF demodulator, downconverting an RF input signal directly to baseband. The single-ended RF input accepts signals from 1500MHz to 2300MHz with power levels up to +30dBm. The passive mixer architecture produces a conversion loss of typically 9.5dB. The downconverter is optimized for high linearity and excellent noise performance, typically with a +38dBm IIP3, an input P1dB of +29.7dBm, and a 9.6dB noise figure.

A wide I/Q port bandwidth allows the port to be used as an image-reject mixer for downconversion to a quadrature IF frequency.

The RF and LO inputs are internally matched to 50Ω. Thus, no matching components are required, and only DC-blocking capacitors are needed for interfacing.

### Power Scaling with Changes to the Bias Resistors

Bias currents for the LO buffers are optimized by fine tuning resistors R1, R2, and R3. Maxim recommends using ±1%-tolerant resistors; however, standard ±5% values can be used if the ±1% components are not readily available. The resistor values shown in the *Typical Application Circuit* were chosen to provide peak performance for the entire 1500MHz to 2300MHz band. If desired, the current can be backed off from this nominal value by choosing different values for R1, R2, and R3. Contact the factory for additional details.

### Layout Considerations

A properly designed PC board is an essential part of any RF/microwave circuit. Keep RF signal lines as short as possible to reduce losses, radiation, and inductance. For the best performance, route the ground pin traces directly to the exposed paddle under the package. The PC board exposed paddle **MUST** be connected to the ground plane of the PC board. It is suggested that multiple vias be used to connect this paddle to the lower level ground planes. This method provides a good RF/thermal conduction path for the device. Solder the exposed paddle on the bottom of the device package to the PC board. The MAX2023 evaluation kit can be used as a reference for board layout. Gerber files are available upon request at [www.maxim-ic.com](http://www.maxim-ic.com).

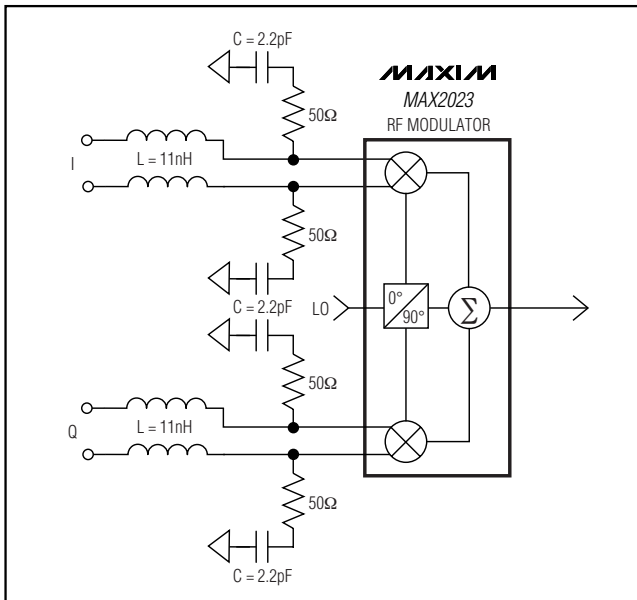

Figure 3. Diplexer Network Recommended for DCS 1800/PCS 1900 EDGE Transmitter Applications

# High-Dynamic-Range, Direct Up-/Downconversion 1500MHz to 2300MHz Quadrature Mod/Demod

### Power-Supply Bypassing

Proper voltage-supply bypassing is essential for high-frequency circuit stability. Bypass all VCC\_ pins with 22pF and 0.1μF capacitors placed as close to the pins as possible, with the smallest capacitor placed closest to the device.

To achieve optimum performance, use good voltage-supply layout techniques. The MAX2023 has several RF processing stages that use the various VCC\_ pins, and while they have on-chip decoupling, off-chip interaction between them may degrade gain, linearity, carrier suppression, and output power-control range. Excessive coupling between stages may degrade stability.

### Exposed Paddle RF/Thermal Considerations

The EP of the MAX2023's 36-pin thin QFN-EP package provides a low thermal-resistance path to the die. It is important that the PC board on which the IC is mounted be designed to conduct heat from this contact. In addition, the EP provides a low-inductance RF ground path for the device.

The exposed paddle (EP) MUST be soldered to a ground plane on the PC board either directly or through an array of plated via holes. An array of 9 vias, in a 3 x 3 array, is suggested. Soldering the pad to ground is critical for efficient heat transfer. Use a solid ground plane wherever possible.

## Pin Configuration/Functional Diagram

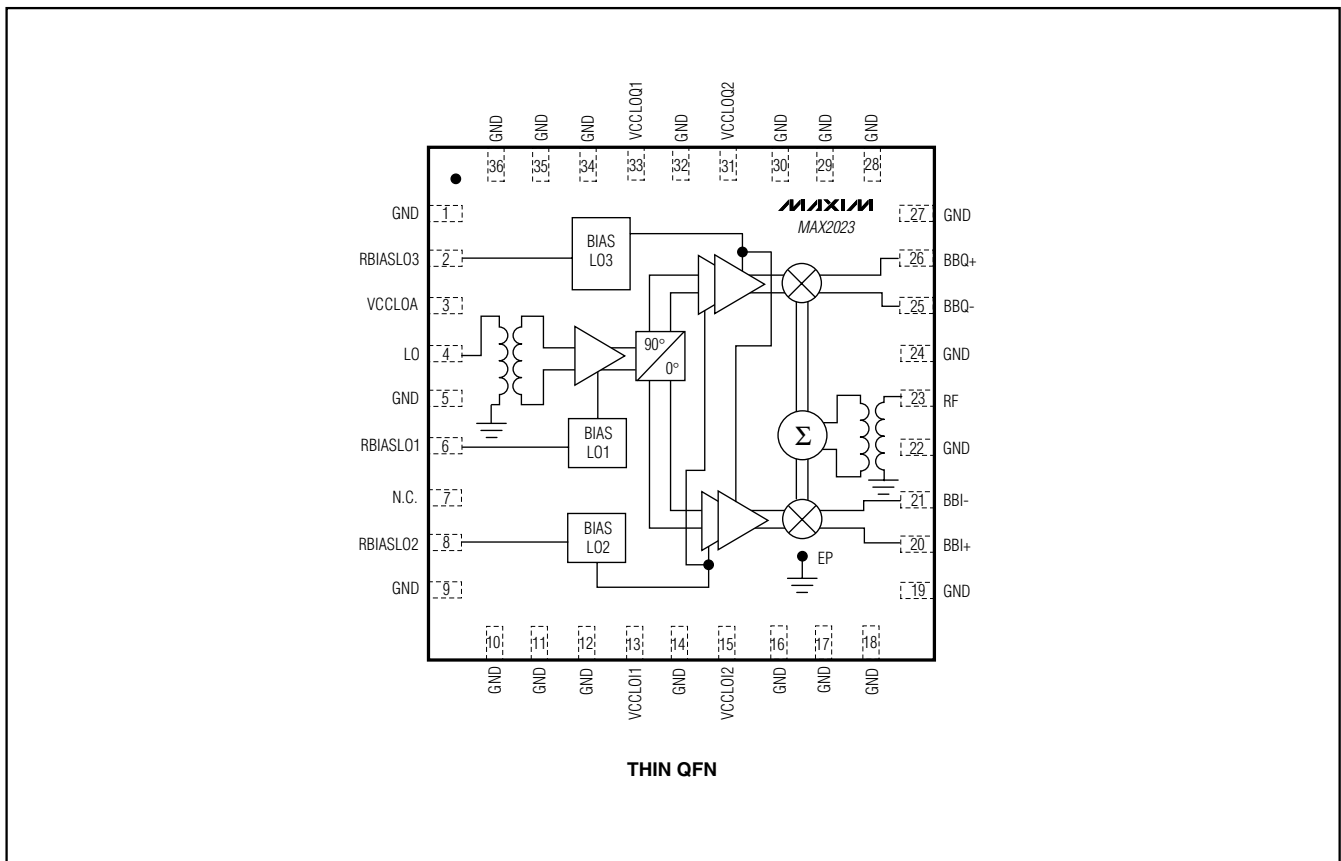

# High-Dynamic-Range, Direct Up-/Downconversion 1500MHz to 2300MHz Quadrature Mod/Demod

## Typical Application Circuit

MAX2023

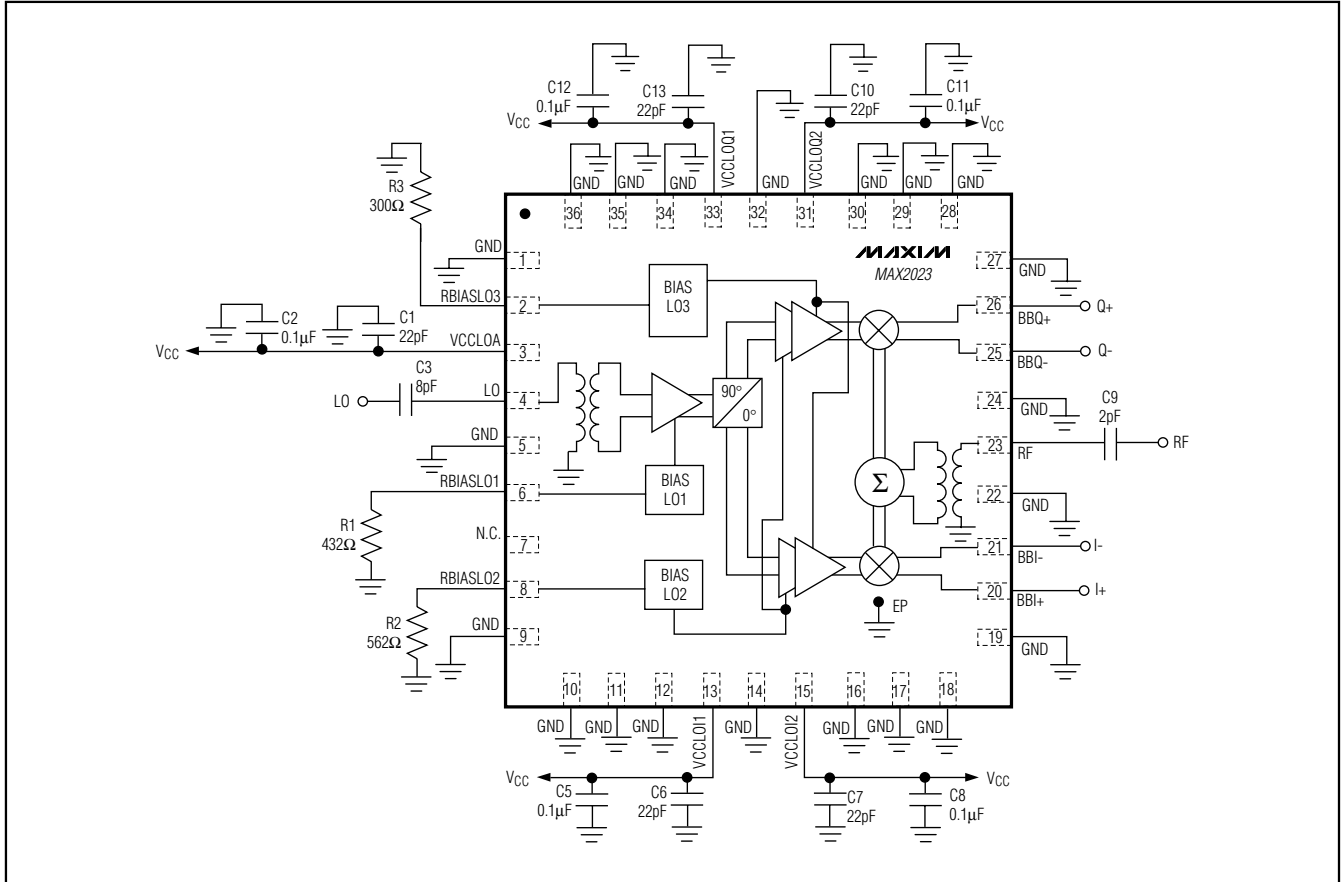

**Table 1. Component List Referring to the Typical Application Circuit**

COMPONENT	VALUE	DESCRIPTION
C1, C6, C7, C10, C13	22pF	22pF ±5%, 50V C0G ceramic capacitors (0402)
C2, C5, C8, C11, C12	0.1µF	0.1µF ±10%, 16V X7R ceramic capacitors (0603)
C3	8pF	8pF ±0.25%, 50V C0G ceramic capacitor (0402)
C9	2pF	2pF ±0.1pF, 50V C0G ceramic capacitor (0402)
R1	432Ω	432Ω ±1% resistor (0402)
R2	562Ω	562Ω ±1% resistor (0402)
R3	300Ω	300Ω ±1% resistor (0402)

### Chip Information

PROCESS: SiGe BiCMOS

### Package Information

For the latest package outline information, go to [www.maxim-ic.com/packages](http://www.maxim-ic.com/packages).

Maxim cannot assume responsibility for use of any circuitry other than circuitry entirely embodied in a Maxim product. No circuit patent licenses are implied. Maxim reserves the right to change the circuitry and specifications without notice at any time.

Maxim Integrated Products, 120 San Gabriel Drive, Sunnyvale, CA 94086 408-737-7600 13